



500 XLS

TREATMENT CHAIR



E

2024V01

ENJOY QUALITY AND DESIGN

500 XLS

Item No.: 1500 0005

Perfect for oral and maxillo-facial surgery treatments, with multifunctional horseshoe-shaped headrest element. For comfortable patient positioning for applications and treatments requiring prone patient positioning.

Our specialist
for ENT treatment



Positioning

Standard recommended memo keys

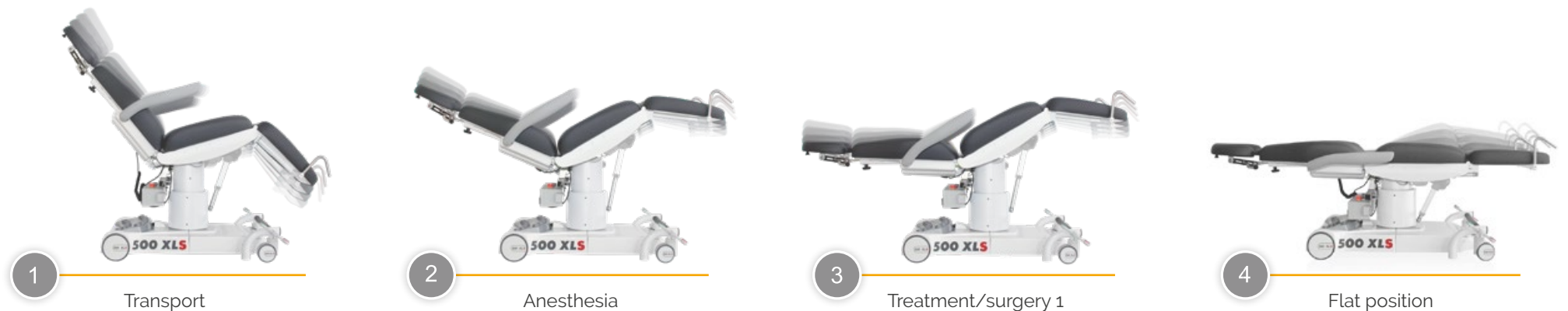

Precise positioning of the head part

Headrest

Multifunctional headrest element featuring two-dimensional and longitudinal adjustment. Horseshoe shape also allows treatments in prone position.

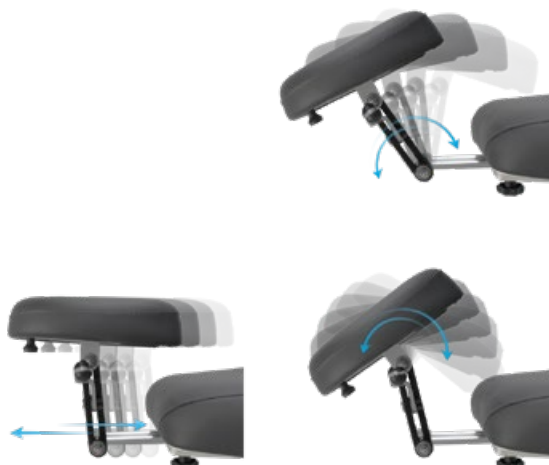

Braking system

Mechanical. Easy to handle.

Rugged moving gear featuring 2 central braking steering castors and 2 rigid castors for high stability combined with easy maneuverability.



Positioning by hand control

Multi-functional manual keypad

 Battery charge indicator



Reset button



CPR button



Auto run function



8 free configurable memory positions



Positioning by foot control

Removable foot keypad

for back, seat and height adjustment, including on-off button, 3 memory positions, and a reset key.



Technical specifications



Chassis

- Frame profile 60 x 30 mm
- Length chassis incl. lever 1,020 mm
- Width chassis outside 710 mm
- Outside width incl. arm rests 830 mm
- White paint finish
- Central brake, operable from both sides
- 2 pcs. double castors \varnothing 100 mm
- 2 pcs. rigid castors \varnothing 150 mm
- Foot keypad, removable
(for overall/back part/seat adjustment;
reset button; auto-run function; 3 memory positions)
- Emergency stop button
- With equipotential bonding connection

Upper frame

- 4-part support frame (head, back, seat, leg part)
- Length 1,930 – 2,160 mm
- Width of upholstery 610 mm
- Entry height 580 mm
- Removeable upholstery

| | Angle | Dimensions (L x W) |
|---------------------|----------|--------------------|
| • Head part | 0°/+180° | 275 x 280 mm |
| • Back part | 0°/+84° | 610 x 610 mm |
| • Seat part | -3°/+32° | 510 x 600 mm |
| • Leg part | 0°/-70° | 490 x 525 mm |
| • Height adjustment | | 580 – 860 mm |
| • Armrests | 0°/+180° | 455 x 75 mm |

Electrical control

- All components according to IP54
- Hand control with 8 individually programmable memory positions, auto run function, reset button
- Foot keypad

Electric Drives

- Back, seat, leg part, total up/down
- Shock position

Lifting column

- Max. lifting 280 mm
- Max. load 200 kg
- Motors IP54 with HAL sensors, to be memorized

Seat part



Back part/leg part



Height adjustment

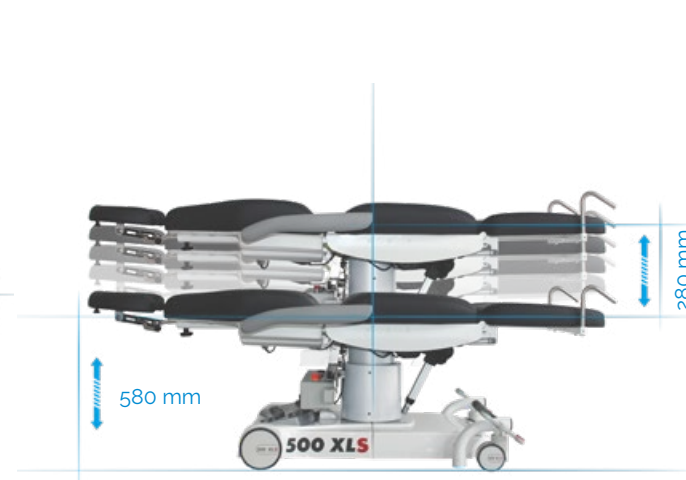

Components



FUNCTIONAL CLASS



500 XLS

Item No.: 1500 0005



Backup battery

Item No.: 3047 0000



I.V. Pole stainless steel
 Ø 25/18 mm, one-hand
 height adjustable
 1.070 – 1.660 mm, 4 hooks,
 max. 2 kg/hook, glass and
 holder (component holder
 3351 0037 not included)

Item No.: 3068 0000



Hand control holder,
 PVC
 (component holder
 3351 0037 not included)

Item No.: 3351 1023



Hand control holder
 for attachment onto an
 I.V. Pole Ø 25/18 mm, PVC

Item No.: 3351 1022



Inlay head pillow

Item No.: 3325 0000



Anesthesia arm board with
 universal joint,
 with wrist secure straps

Item No.: 3078 0000



Norm rail 300 mm, seat part

Item No.: 3321 0000



Norm rail, back part

Item No.: 3320 0000



Instrument table 500x300x15 mm, height adjustable, swiveling, detachable, incl. adapter (component holder 3351 0037 not included)

Item No.: 3065 0000

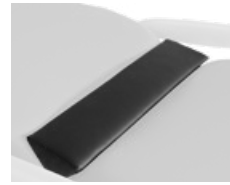

Trapeze cushion, wedge, for back/seat part

Item No.: 3022 0005



Knee half roll, 600x280x140 mm, PUD-coated

Item No.: 3019 0000



Knee roll round, 500x150 mm, PUD-coated

Item No.: 3050 0000



Wrist secure straps, pair

Item No.: 3015 0000



Body strap with Velcro straps, 2-piece

Item No.: 3083 0000



Side rails right and left, swiveling incl. locking, upholstered

Item No.: 3351 1036



Foot protection foil

Item No.: 3326 0000



Component arm stainless steel, swiveling, incl. extendible I.V. Pole Ø 25 mm

Item No.: 3024 0014



Component holder, stainless steel

Item No.: 3351 0037



Pushing handles, pair

Item No.: 3069 0000



Flexible surgical drape support rod with air connection, incl. norm rail and mounting clamp

Item No.: 3351 0009



Flexible surgical drape support rod, incl. norm rail and mounting clamp

Item No.: 3351 0010

Hygiene products



Cover drape for treatment chair, **stayClean** 2.000x730 mm, box à 160 pieces

Item No.: 3034 0014



NEW

Kick bucket, capacity 12L, **stayClean** kick bucket

Item No.: 3351 1046

Medical product



Instrument table **supportLine** height adjustable 730-1,000 mm

Item No.: 3351 0026

“skai® Tundra”



High quality skai® material with fine calf leather grain and subdued matte-gloss-effect. The very extensive and trend-orientated color spectrum enables many applications and combinations.

Product Specification

- Long-lasting
- Tear resistant
- Easy to clean
- Abrasion resistant (DIN EN ISO 6570-2)
- Lightfast
- Disinfectant resistant
- Biocompatibility: cytotoxicity (EN ISO 10 993-5) and epicutaneous test (EN ISO 10 993-10)
- Blood- and urine resistant
- Phthalate-free
- Vegan

| | |
|-------------------------|-----------------------|
| <i>eyeForce</i> | 1800 0000 |
| <i>500 XLE</i> | 1500 0006 |
| <i>500 XLE comfort</i> | 1500 0006 |
| | + 3037 0080 |
| <i>500 XLS</i> | 1500 0005 |
| <i>500 ECO</i> | 1500 0008 |
| <i>400 XL</i> | 1400 0001 |
| <i>surgiForce</i> | Formed seat 2600 0008 |
| <i>surgiForce light</i> | Formed seat 2600 0009 |
| <i>surgiLine</i> | Formed seat 2200 0008 |
| <i>assistLine</i> | 2400 0015 |
| <i>motionLine</i> | 1700 0000 |
| <i>motionLine-E</i> | 1700 0001 |

+ Item No.: 3037 0...

| | | | | | | | |
|--|--|---|---|--|---------------------------------------|--|---------------------------------------|
| | | | | | | | |
| weiß F6461198 Item No.:134 | creme F6461210 Item No.:057 | beige F6461636 Item No.:094 | sand F6461230 Item No.:058 | pistazio F6461610 Item No.:153 | mint F6461495 Item No.:067 | aqua F6461456 Item No.:001 | türkis F6461338 Item No.:008 |
| | | | | | | | |
| perle F6461288 Item No.:007 | silber F6461550 Item No.:070 | stone F6461608 Item No.:075 | bleu F6461496 Item No.:068 | dolphin F6461609 Item No.:076 | sky F6461581 Item No.:073 | royal F6461196 Item No.:051 | atoll F6461453 Item No.:062 |
| | | | | | | | |
| violett F6461356 Item No.:059 | cyclame F6461381 Item No.:119 | orchidee F6461354 Item No.:011 | bordeaux F6461350 Item No.:010 | kirsche F6461199 Item No.:054 | feuer F6461454 Item No.:063 | karneol F6461557 Item No.:072 | orange F6461556 Item No.:071 |
| | | | | | | | |
| apricot F6461458 Item No.:066 | mais F6461457 Item No.:065 | mango F6461607 Item No.:074 | safran F6461542 Item No.:069 | limonade F6461343 Item No.:009 | limone F6461543 Item No.:109 | smaragd F6461455 Item No.:064 | agave F6461273 Item No.:006 |
| | | | | | | | |
| chrom F6461205 Item No.:056 | ocean F6461204 Item No.:055 | schoko F6461357 Item No.:060 | schwarz F6461195 Item No.:050 | anthrazit F6461197 Item No.:052 | | | |

The colors displayed on your device may differ slightly from the original colors. If you wish to receive original color charts, please contact us at info@ufsk-osys.com.

“skai® Pandoria Plus”



skai® Pandoria Plus is a high-quality upholstery material, whose fine micropore structure gives a certain unobtrusiveness, which is refined by an attractive tone-in-tone effect. The very pleasant feel of the material and the excellent material characteristic and the broad, modern color spectrum make skai® Pandoria Plus universally usable.











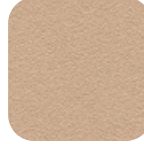
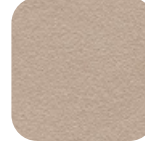
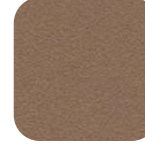

Product Specification

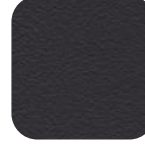
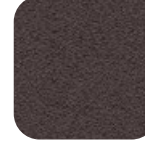
- Long-lasting
- Tear resistant
- Easy to clean
- Abrasion resistant (DIN EN ISO 5470-2)
- Resistant to oil and fat
- Lightfast
- Disinfectant resistant
- Flame protection
- Biocompatibility: cytotoxicity (EN ISO 10 993-5) and epicutaneous test (EN ISO 10 993-10)
- Resistant to sudor, blood and urine
- Antibacterial according to JIS Z 2801
- Vegan

| | | |
|-------------------------|-------------|-------------|
| <i>eyeForce</i> | | 1800 0000 |
| <i>500 XLE</i> | | 1500 0006 |
| <i>500 XLE comfort</i> | | 1500 0006 |
| | | + 3037 0080 |
| <i>500 XLS</i> | | 1500 0005 |
| <i>500 ECO</i> | | 1500 0008 |
| <i>400 XL</i> | | 1400 0001 |
| <i>surgiForce</i> | Formed seat | 2600 0008 |
| <i>surgiForce light</i> | Formed seat | 2600 0009 |
| <i>surgiLine</i> | Formed seat | 2200 0008 |
| <i>assistLine</i> | | 2400 0015 |
| <i>motionLine</i> | | 1700 0000 |
| <i>motionLine-E</i> | | 1700 0001 |

+ Item No.: 3037 0136

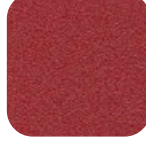
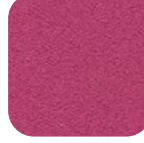
+ Item No.: 3037 0...

| | | | | |
|---|--|--|--|--|
|  |  |  |  |  |
| weiß F6413046 Item No.:053 | hellbeige F6413047 Item No.:141 | kiesel F6413048 Item No.:158 | birke F6413049 Item No.:159 | smoke F6413050 Item No.:221 |
|  |  |  |  |  |
| silbergrau F6413075 Item No.:275 | platin F6413053 Item No.:161 | anthrazit F6413076 Item No.:276 | schwarz F6413052 Item No.:170 | schoko F6413051 Item No.:160 |
|  |  |  |  |  |
| gletscher F6413055 Item No.:162 | sky F6413074 Item No.:277 | royal F6413056 Item No.:163 | smaragd F6413073 Item No.:278 | kaktus F6413077 Item No.:281 |
|  |  |  |  |  |
| feuer F6413058 Item No.:166 | kirsche F6413079 Item No.:279 | fuchsia F6413078 Item No.:280 | mais F6413057 Item No.:164 | limone F6413054 Item No.:165 |

The colors displayed on your device may differ slightly from the original colors. If you wish to receive original color charts, please contact us at info@ufsk-osys.com.

Upgrade your OR to perfection.



eyeForce



500 XLE



500 XLE comfort



500 XLS



500 ECO



400 XL



motionLine



motionLine-E



surgiForce



surgiForce light



surgiTrend



surgiLine



stayClean



stayClean roll



stayClean kick bucket



supportLine



assistTrend



assistPro F



assistPro H



easyPro F



easyPro R



easyLine F



easyLine R



assistLine

CONTACT US



UFSK
INTERNATIONAL

OSYS

UFSK-International OSYS GmbH
Kirchhoffstraße 1
93055 Regensburg
Germany

Tel. +49 (0) 941 78862 15
Fax +49 (0) 941 78862 35
E-Mail info@ufsk-osys.com
Web ufsk-osys.com

MADE IN GERMANY
Design | Construction | Manufacturing